

TOP

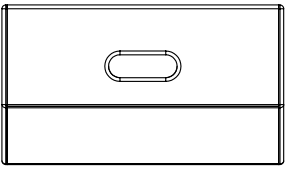

SIDE

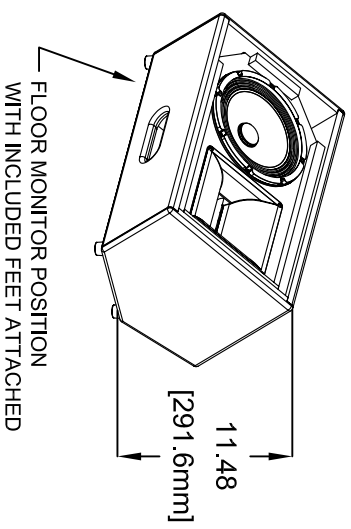
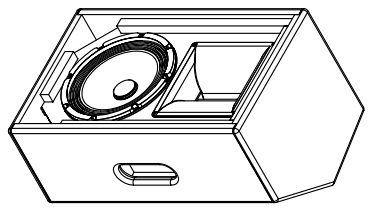
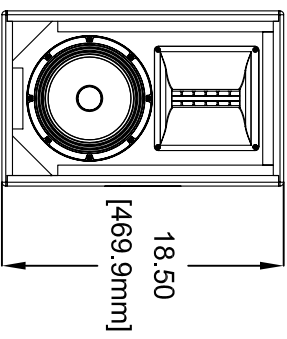

FRONT

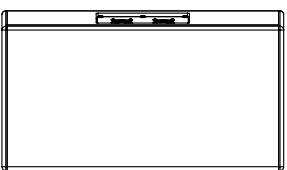

SIDE

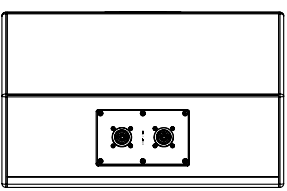

BACK

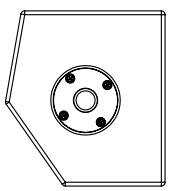

BOTTOM

UNLESS OTHERWISE SPECIFIED		TOLERANCE	
1. NO NET SCALE DRAWING		X/X = ±1/64	
2. DIMENSIONS ARE IN INCHES AND MILLIMETERS		XXX = ±.03	
		XXX = ±.010	
		ANGULAR ±5°	
MATERIAL	AS SPECIFIED	FINISH	✓
FINISH	AS SPECIFIED	DRAWN BY	DATE
AS SPECIFIED		P. SPURLOCK	07/18/08
		CHECKED BY	
		APPROVED BY	
SLS LOUDSPEAKERS		MECHANICAL SPECIFICATION	
1650 W. JACKSON STREET		8190V2 CABINET	
DZARK, MISSOURI 65721		DWG. NO. W-8190V2	
417-883-4549 Fax: 417-883-2723		SCALE 1/1	
		SHEET 1 OF 1	
		REV. 0	
		1	