



Product Technical Data Sheet
Model LS8800 / LS8800-I

Description

The LS8800 is a full-range bi-amped true line source array module. While compact in size it meets high SPL line array performance requirements for a wide variety of venues. Typical generated listening area SPL can be up to 115dB.

The LS8800 high frequency section features a high performance PRD1000 planar ribbon transducer designed and manufactured by SLS Loudspeakers. The unique design and properties of the planar ribbon driver allows precise acoustical coupling of the array and hence, full utilization of line source (cylindrical waves) benefits.

The low frequency section uses two high-powered 8" drivers utilizing a demodulation ring magnet system providing a third less harmonic distortion and reducing inductance modulation by 50 percent. This provides an open and clear sound despite loud listening levels. Additionally, the low frequency drivers feature a die-cast basket with a patented Intercooler system.

Key Features

- Direct radiating planar PRD1000 ribbon high frequency line source module delivers unsurpassed sound quality
- True line source behavior due to precise acoustical coupling of individual PRD1000 high frequency transducers
- Open and clear sound at high SPL due to advanced transducer technology in all bandwidth sections
- 110 degree wide horizontal coverage
- Even and easily predictable coverage using our free LASS prediction software.
- All array rigging is included
- Splay options from 1 to 10 degrees between boxes
- ¾" 13 ply Baltic Birch cabinet construction

Applications

- Developed for a wide range of professional applications where the highest quality and intelligibility of sound is required
- For permanent sound reinforcement installations in churches, auditoriums, arenas performing arts centers, etc.
- Professional portable PA system for a wide variety of applications



Product Specifications	
Operating Range ¹	72Hz - 20,000Hz
Sensitivity (1W/1M) - Low Freq. ²	98dB
High Freq.	103dB
Horizontal Coverage Angle -6dB ³	110 Degrees
Vertical Coverage Angle	Defined by height and configuration of the array
Power Handling - Low Freq. ⁴	500W (64 Volts) AES/2
High Freq.	385W (50 Volts) IEC Short Term 104W (26 Volts) IEC Long Term 60W (20 Volts) AES/2
Recommended Amp Power for Max Output	
Low Freq.	1000 Watts @ 8 ohms
High Freq.	400 Watts @ 8 ohms
Max SPL (calculated) 1 Meter - Low Freq. ⁵	125dB Cont. / 131dB Peak
High Freq.	123dB Cont. / 129dB Peak
Nominal Impedance - Low Freq.	8 Ohms
High Freq.	6.5 Ohms
Crossover Frequency	DSP Settings Provided
Transducers - Low Freq.	8" Bass/Midrange x 2
High Freq.	PRD1000 Ribbon
Input	NL4 x2 (Pair 1 = LF, Pair 2 = HF) Barrier Strip for I versions
Dimensions	9.62" (24.5cm) H (front side) 7.65" (19.4cm) H (rear side) 28.25" (71.8cm) W 13" (33cm) D
Enclosure	13ply Baltic Birch
Weight	60lbs (27.2kg) Shipping 67lbs (30.4kg)
Rigging	All array rigging is included
Optional Accessories	RLA/2-BB - Rigging Frame ⁶ RC-LS8800 Road case (holds 4 LS8800s)
Finish Options	Black Latex White Latex (w/ white rigging) Paintable Natural Finish (w/ black rigging)

1. LF at -10dB, HF -6dB at 30kHz on-axis however response above 20kHz is limited by air absorption and DSP sampling rates in typical PA applications.
 2. Full bandwidth pink noise is applied and amplified to a level and measured at the loudspeaker terminals - corresponding to 1 Watt as referenced to the loudspeakers nominal impedance. SPL is measured in an anechoic environment in the loudspeakers far field. Data is extrapolated to 1 Meters distance from the loudspeaker.
 3. Averaged from 1000Hz to 10kHz
 4. AES established with ambient temperature at 22C in accordance with AES/2-1984 standard. IEC stated in RMS voltage according to IEC 268-5
 5. Typical SPL for one box only, for array SPL refer to LASS calculations. Ribbon SPL calculated from IEC long term and short term
 6. Rigging Frame weight is 37lbs



LS8800 / LS8800-I Drawings

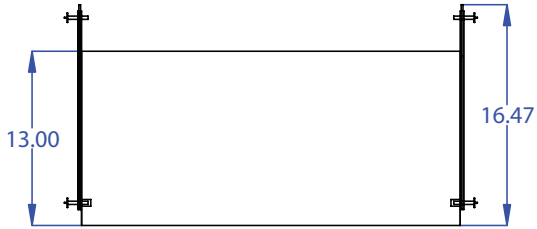

TOP

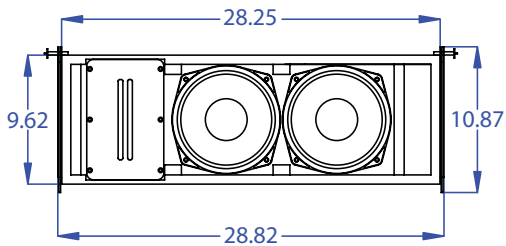

FRONT

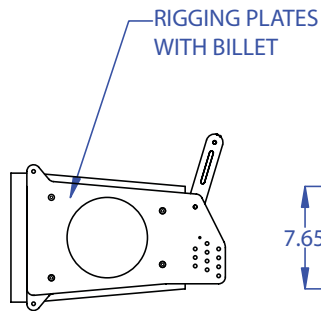

SIDE

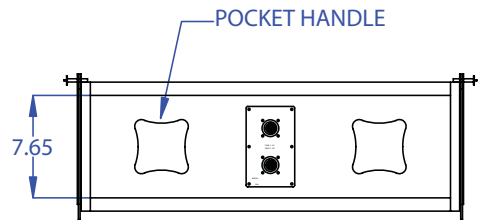

BACK

Polars

Horizontal Axis 

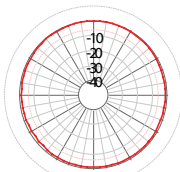

125Hz

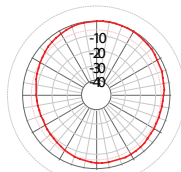

250Hz

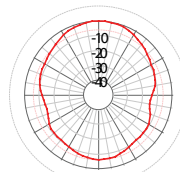

500Hz

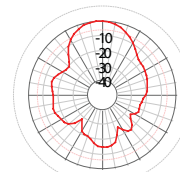

1000Hz

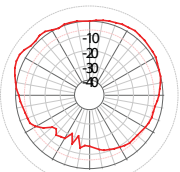

2000Hz

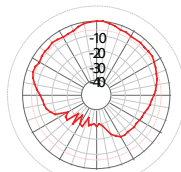

4000Hz

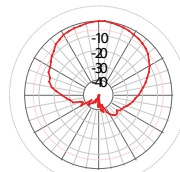

8000Hz